

calibri
a corsoio



softmetal
italiana s.r.l.

217-218  1/03 190	102-108  1/03 219	103-106  1/03 205	151  1/04 205
1/04 	1/04 	1/05 	1/05 
160-214  1/05	299  1/05	231  1/06	232-238-239  1/06
228  1/07	229  1/07	224-225  1/07	158-257  1/08
130  1/08	226-230  1/08	266  1/09	281-282  1/09
286-292  1/10	270  1/11	269  1/11	272  1/11
274-275  1/11	278  1/11	261  1/12	263  1/12
262  1/12	268  1/12	253  1/13	255  1/13

Calibri ad orologio Vogel qualità extra
lettura 0,02 o 0,01mm - astuccio plastica
Uhrenschiebelehren Vogel von hoher Qualitaet
Ablesung 0,02 oder 0,01mm - Plastiketu
Dial calipers Vogel of extra quality
reading 0,02 or 0,01mm - plastic box

Codice N°	Utile mm	Becchi mm	Lettura
<i>Bestell Nr.</i>	<i>Messbereich</i>	<i>Schnaebel</i>	<i>Ablesung</i>
<i>Order code</i>	<i>Capacity</i>	<i>Jaws</i>	<i>Reading</i>
<i>Lettura 1/50° - Ablesung 1/50 - Reading 0,02</i>			
217.501	150	40	0,02
217.502	200	50	0,02
217.503	300	60	0,02
<i>Lettura 1/100° - Ablesung 1/100 - Reading 0,01</i>			
218.501	150	40	0,01
218.502	200	50	0,01
218.503	300	60	0,01

Calibri orologio

Uhrenschiebelehren
Dial calipers

VOGEL
217-8

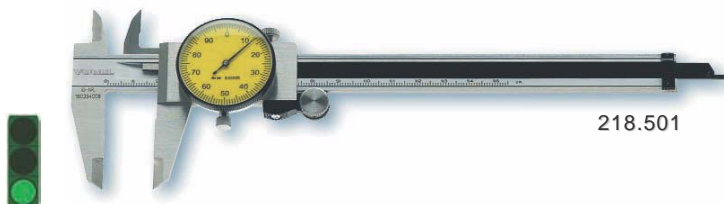

218.501

Calibri economici Vtec - nonio 1/20-1/128"
bloccaggio a pulsante - fodero o astuccio plastica
Billig-Taschenschiebelehren Vtec - Nonius 1/20+1/128"
Momentverstellung - Tasche oder Etui aus Plastik
Economical vernier calipers Vtec - reading 1/20+1/128"
thumb lock - plastic pocket or box

Codice N°	Utile mm	Becchi mm	Nonio
<i>Bestell Nr.</i>	<i>Messbereich</i>	<i>Schnaebel</i>	<i>Nonius</i>
<i>Order code</i>	<i>Capacity</i>	<i>Jaws</i>	<i>Reading</i>
001.102	150	40	0,05
001.105	200	50	0,05

Calibri con nonio avvitato

Schiebelehren mit Schraubnonius
Vernier calipers with screwed vernier

Vtec
102



001.102

Calibri economici Vtec - nonio 1/20-1/128"
bloccaggio a vite - fodero o astuccio plastica
Billig-Taschenschiebelehren Vtec - Nonius 1/20+1/128"
Feststellschraube - Tasche oder Etui aus Plastik
Economical vernier calipers Vtec - reading 1/20+1/128"
screw lock - plastic pocket or box

Codice N°	Utile mm	Becchi mm	Nonio
<i>Bestell Nr.</i>	<i>Messbereich</i>	<i>Schnaebel</i>	<i>Nonius</i>
<i>Order code</i>	<i>Capacity</i>	<i>Jaws</i>	<i>Reading</i>
001.108	150	40	0,05
001.110	200	50	0,05

Calibri con nonio avvitato

Schiebelehren mit Schraubnonius
Vernier calipers with screwed vernier

Vtec
108



001.108

Calibri standard Midway - nonio 1/20-1/128"
bloccaggio a pulsante - fodero o astuccio plastica
Standard-Taschenschiebelehren Midway - Nonius 1/20+1/128"
Momentverstellung - Tasche oder Etui aus Plastik
Standard vernier calipers Midway - reading 1/20+1/128"
thumb lock - plastic pocket or box

Codice N°	Utile mm	Becchi mm	Nonio
<i>Bestell Nr.</i>	<i>Messbereich</i>	<i>Schnaebel</i>	<i>Nonius</i>
<i>Order code</i>	<i>Capacity</i>	<i>Jaws</i>	<i>Reading</i>
001.103	150	40	0,05
001.113	200	50	0,05
001.123	300	60	0,05

Calibri monoblocco

Schiebelehren - Monoblock
Vernier calipers - Monoblock

Midway
103

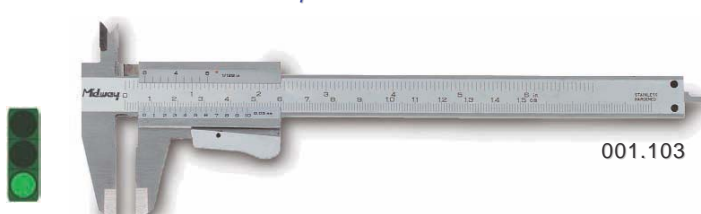

001.103

Calibri standard Midway - nonio 1/20-1/128"
bloccaggio a vite - fodero o astuccio plastica
Standard-Taschenschiebelehren Midway - Nonius 1/20+1/128"
Feststellschraube - Tasche oder Etui aus Plastik
Standard vernier calipers Midway - reading 1/20+1/128"
screw lock - plastic pocket or box

Codice N°	Utile mm	Becchi mm	Nonio
<i>Bestell Nr.</i>	<i>Messbereich</i>	<i>Schnaebel</i>	<i>Nonius</i>
<i>Order code</i>	<i>Capacity</i>	<i>Jaws</i>	<i>Reading</i>
001.106	150	40	0,05
001.116	200	50	0,05
001.126	300	60	0,05

Calibri monoblocco

Schiebelehren - Monoblock
Vernier calipers - Monoblock

Midway
106

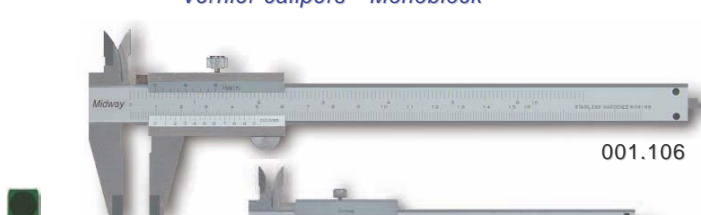

001.106

Codice N°	Utile mm	Becchi mm	Nonio
<i>Bestell Nr.</i>	<i>Messbereich</i>	<i>Schnaebel</i>	<i>Nonius</i>
<i>Order code</i>	<i>Capacity</i>	<i>Jaws</i>	<i>Reading</i>
001.100	70	20	0,05
001.101	100	30	0,05



001.101

001.100

Midway
151

Calibri per mancini

Linkshaenderschiebelehre
Left hand vernier calipers

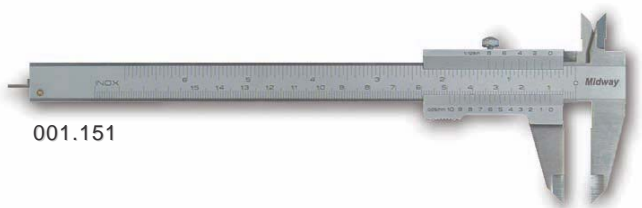

001.151

Calibri Midway per mancini - nonio 1/20-1/128"
bloccaggio a pulsante o vite - fodero plastica
Taschenschiebelehren Midway fuer Linkshaender - Nonius 1/20+1/128" - Momentverstellung/Schraube - Plastiktasche
Vernier calipers Midway for left handers - reading 1/20+1/128"
thumb or screw lock - plastic pocket

Codice N°	Utile mm	Becchi mm	Nonio
<i>Bestell Nr.</i>	<i>Messbereich</i>	<i>Schnaebel</i>	<i>Nonius</i>
<i>Order code</i>	<i>Capacity</i>	<i>Jaws</i>	<i>Reading</i>
Bloc. vite - <i>Feststellschraube</i> - <i>Screw lock</i>			
001.151	150	40	0,05
Bloc. pulsante - <i>Momentverst.</i> - <i>Thumb lock</i>			
001.152	150	40	0,05

VOGEL
190

Calibri monoblocco top quality

Schiebelehren - Monoblock Top Qualitaet
Vernier calipers - Monoblock top quality

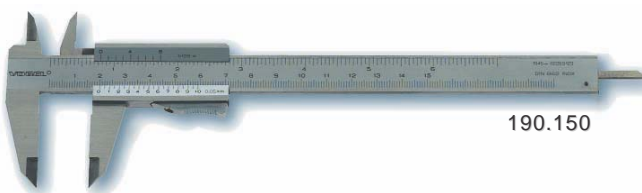

190.150

Calibri Vogel top quality - nonio 1/20-1/128"
bloccaggio a pulsante - fodero plastica in cartone
Taschenschiebelehren Vogel in Top Qualitaet - Nonius 1/20+1/128" Momentverstellung - Plastiktasche in Karton
Vernier calipers Vogel of top quality - reading 1/20+1/128"
thumb lock - plastic pocket in carton box

Codice N°	Utile mm	Becchi mm	Nonio
<i>Bestell Nr.</i>	<i>Messbereich</i>	<i>Schnaebel</i>	<i>Nonius</i>
<i>Order code</i>	<i>Capacity</i>	<i>Jaws</i>	<i>Reading</i>
190.150	150	40	0,05
190.200	200	50	0,05
190.300	300	60	0,05

Midway
219

Calibri digitali standard e speciali

Digitalschiebelehren Standard und Spezial
Digital calipers standard and special types



009.150

Calibri digitali Midway - modelli, disegno e colori aste variabili
scatola plastica - articoli soggetto a frequenti cambiamenti
l'ultima versione vedi foto Promo opp. in internet
Digitalschiebelehren Midway - Modelle, Design und Farben Masstab variabel - Plastiketui - diese Artikel sind in staendigem Wechsel letzte Version siehe unser Sonderangebot oder Internetseite
Digital calipers Midway - models, desing, and colours of scale variable
plastic box - items subject to frequent changings and modifications
last version see our promotion or web site

Codice N°	Utile mm	Becchi mm	Letture
<i>Bestell Nr.</i>	<i>Messbereich</i>	<i>Schnaebel</i>	<i>Ablesung</i>
<i>Order code</i>	<i>Capacity</i>	<i>Jaws</i>	<i>Reading</i>
009.150	150	40	0,01-0.001"
009.200	200	50	0,01-0.001"
009.300	300	60	0,01-0.001"
999.999	Pila - <i>Batterie</i> - <i>Battery</i>		



ABS

009.181

Codice N°	Utile mm	Becchi mm	Letture
<i>Bestell Nr.</i>	<i>Messbereich</i>	<i>Schnaebel</i>	<i>Ablesung</i>
<i>Order code</i>	<i>Capacity</i>	<i>Jaws</i>	<i>Reading</i>
009.181	150	40	0,01-0.001"
009.182	200	45	0,01-0.001"
009.183	300	60	0,01-0.001"
999.999	Pila - <i>Batterie</i> - <i>Battery</i>		



009.175

Codice N°	Utile mm	Becchi mm	Letture
<i>Bestell Nr.</i>	<i>Messbereich</i>	<i>Schnaebel</i>	<i>Ablesung</i>
<i>Order code</i>	<i>Capacity</i>	<i>Jaws</i>	<i>Reading</i>
Metallo duro - <i>Hartmetall</i> - <i>Carbide steel</i>			
009.175	150	40	0,01-0.001"
999.999	Pila - <i>Batterie</i> - <i>Battery</i>		



009.158

Codice N°	Utile mm	Becchi mm	Letture
<i>Bestell Nr.</i>	<i>Messbereich</i>	<i>Schnaebel</i>	<i>Ablesung</i>
<i>Order code</i>	<i>Capacity</i>	<i>Jaws</i>	<i>Reading</i>
Cal. mancini - <i>Linkshaendersch.</i> - <i>Left hand v.c.</i>			
009.158	150	40	0,01-0.001"
999.999	Pila - <i>Batterie</i> - <i>Battery</i>		



009.156

Ø1,6

Codice N°	Utile mm	Becchi mm	Letture
<i>Bestell Nr.</i>	<i>Messbereich</i>	<i>Schnaebel</i>	<i>Ablesung</i>
<i>Order code</i>	<i>Capacity</i>	<i>Jaws</i>	<i>Reading</i>
Asta tonda - <i>Rundes Tiefenmass</i> - <i>Round depth rod</i>			
009.156	150	40	0,01-0.001"
009.157	200	50	0,01-0.001"
999.999	Pila - <i>Batterie</i> - <i>Battery</i>		

Calibri digitali Vogel - lettura 0,01mm/0.001" - cassa metallica argento - display grande - scatola plastica
 Digitalschiebelehren Vogel - Ablesung 0,01mm/0.001" - silbernes Metallgehäuse - grosses Display - Plastiketui
 Digital calipers Vogel - reading 0,01mm/0.001" - silver metal case display LCD with big numbers - plastic box

Codice N° Bestell Nr. Order code	Utile mm Messbereich Capacity	Becchi mm Schnaebel Jaws	Letture Ablesung Reading
205.100	100	30	0,01-0.001"
205.150	150	40	0,01-0.001"
205.200	200	50	0,01-0.001"
205.300	300	60	0,01-0.001"
999.999	Pila - Batterie - Battery		

Esecuzioni speciali con becchi lunghi o punte alte
 astuccio legno nero
 Spezialausführungen mit langen Schnaebeln oder Spitzen
 schwarzer Holzkasten
 Special executions with long jaws or upper jaws
 black wooden box

Codice N° Bestell Nr. Order code	Utile mm Messbereich Capacity	Becchi mm Schnaebel Jaws	Punte mm Spitzen Upper jaws
Becchi lunghi - lange Schnaebel - long jaws			
205.280	200	80	16
Punte alte - lange Spitzen - long upper jaws			
205.290	200	50	45

Calibri digitali UPM - protezione IP65 (prossimamente IP67)
 cassa metallica argento - astuccio legno nero
 Digitalschiebelehren UPM - Schutzart IP65 (demnaechst IP67)
 silbernes Metallgehäuse - schwarzer Holzkasten
 Digital calipers UPM - protection IP65 (shortly IP67)
 silver metal case - black wooden box

Codice N° Bestell Nr. Order code	Utile mm Messbereich Capacity	Becchi mm Schnaebel Jaws	Letture Ablesung Reading
009.160	150	40	0,01-0.001"
009.162	200	50	0,01-0.001"
009.163	300	60	0,01-0.001"
999.999	Pila - Batterie - Battery		

Calibri digitali Midway - protezione IP67 - conversione mm/inch
 cassa metallica argento - astuccio plastica
 Digitalschiebelehren Midway - Schutzart IP67 - Umschaltung
 mm/inch - silbernes Metallgehäuse - Plastiketui
 Digital calipers Midway - protection IP67 - conversion mm/inch
 silver metal case - plastic box

Codice N° Bestell Nr. Order code	Utile mm Messbereich Capacity	Becchi mm Schnaebel Jaws	Letture Ablesung Reading
009.191	150	40	0,01-0.001"
009.192	200	50	0,01-0.001"
999.996	Pila - Batterie - Battery		

Calibri digitali Vogel - protezione IP65 - elettronica Sylvac con uscita dati Opto RS232 - conversione mm/inch - lettura 0,01mm opp. .0005" - precisione DIN 862 - astuccio legno
 Digitalschiebelehren Vogel - Schutzart IP65 - Sylvac Elektronik mit Datenausgang Opto RS232 - Umschaltung mm/inch - Ablesung 0,012mm oder .0005" - Praezision DIN 862 - Holzkasten
 Digital calipers Vogel - protection class IP65 - Sylvac electronic with data socket Opto RS232 - conversion mm/inch - reading 0,01mm or .0005" - precision DIN 682 - wooden box

Codice N° Bestell Nr. Order code	Utile mm Messbereich Capacity	Becchi mm Schnaebel Jaws	Uscita Ausgang Socket
299.721	150	40	Opto RS232
299.723	200	40	Opto RS232
996.701	Cavo - Kabel - Cable		
999.996	Pila - Batterie - Battery		

Calibri digitali - cassa metallica

Digitalschiebelehren mit Metallgehäuse
 Digital calipers with metal case

VOGEL
205

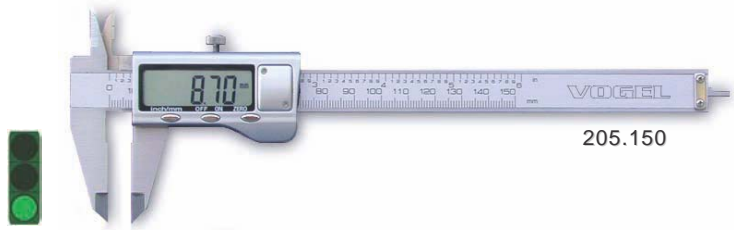

Calibri digitali - IP65 (IP67)

Digitalschiebelehren - Schutzart IP65 (IP67)
 Digital calipers - protection IP65 (IP67)

U P M
160



Calibri digitali - IP67

Digitalschiebelehren - Schutzart IP67
 Digital calipers - protection IP67

Midway
214



Calibri digitali Sylvac system IP65

Digitalschiebelehren Sylvac System IP65
 Digital calipers Sylvac system IP65

VOGEL
299



Vtec
231

Cinquantesimali - nonio avvitato

Werkstattsschiebelehren Schraubnonius
Workshop calipers screwed vernier

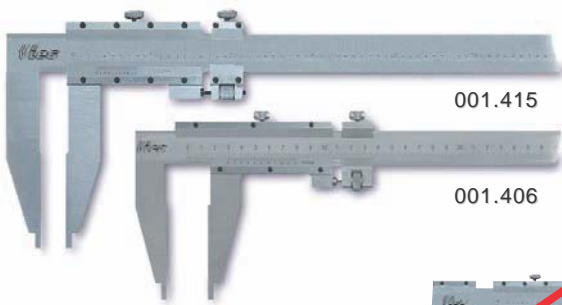

001.415

001.406

Becchi mm = Lunghezza (misura interna)
Schnaebel mm = Laenge (Innenmass)
Jaw mm = Length (internal size)

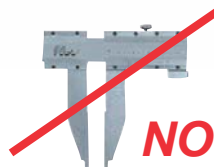

Calibri officina Vtec - nonio 1/50° avvitato
a richiesta anche 1/20°/0,05 - astuccio legno
Werkstattsschiebelehren Vtec - Schraubnonius 1/50
auf Anfrage 1/20°/0,05 - einfacher Holzkasten
Workshop vernier calipers Vtec - screwed vernier 1/50
on request 1/20°/0,05 - simple wooden box

Codice N° <i>Bestell Nr.</i> <i>Order code</i>	Utile mm <i>Messbereich</i> <i>Capacity</i>	Becchi mm <i>Schnaebel</i> <i>Jaws</i>	Nonio <i>Nonius</i> <i>Reading</i>
001.403	300	90 (5+5)	0,02
001.406	500	100 (5+5)	0,02
001.408	500	150 (5+5)	0,02
001.407	600	100 (5+5)	0,02
001.409	600	150 (5+5)	0,02
001.404	800	150 (10+10)	0,02
001.411	1000	150 (10+10)	0,02
001.415	1500	200 (10+10)	0,02
001.420	2000	200 (10+10)	0,02
001.421	2000	300 (10+10)	0,02
001.425	2500	300 (10+10)	0,02
001.430	3000	300 (10+10)	0,02

Midway
232

Cinquantesimali - monoblocco

Werkstattsschiebelehren Monoblock
Workshop calipers monoblock



001.633

Becchi mm = Lunghezza (misura interna)
Schnaebel mm = Laenge (Innenmass)
Jaw mm = Length (internal size)

Nuove misure - *neue Laengen* - *new lengths*

Calibri officina Midway inox - nonio 1/50° - monoblocco
a richiesta anche 1/20°/0,05 - astuccio legno
Werkstattsschiebelehren Midway rostfrei - Nonius 1/50 - Monoblock
auf Anfrage 1/20°/0,05 - Holzkasten
SS Workshop vernier calipers Midway - vernier 1/50
on request 1/20°/0,05 - wooden box

Codice N° <i>Bestell Nr.</i> <i>Order code</i>	Utile mm <i>Messbereich</i> <i>Capacity</i>	Becchi mm <i>Schnaebel</i> <i>Jaws</i>	Nonio <i>Nonius</i> <i>Reading</i>
001.633	300	90 (5+5)	0,02
001.762	300	150 (5+5)	0,02
001.632	400	90 (5+5)	0,02
001.764	400	150 (5+5)	0,02
001.634	500	100 (5+5)	0,02
001.635	500	150 (5+5)	0,02
001.769	500	250 (10+10)	0,02
001.636	600	100 (5+5)	0,02
001.637	600	150 (5+5)	0,02
001.774	600	300 (10+10)	0,02
001.638	800	150 (10+10)	0,02
001.639	1000	150 (10+10)	0,02
001.775	1000	300 (10+10)	0,02
001.776	1000	500 (10+10)	0,02
001.640	1500	200 (10+10)	0,02
001.641	1500	300 (10+10)	0,02
001.777	1500	500 (10+10)	0,02
001.645	2000	200 (10+10)	0,02
001.647	3000	300 (10+10)	0,02

Midway
238-9

Cinquantesimali con punte

Werkstattsschiebelehren mit Spitzen
Workshop calipers with upper jaws



001.665*

Altre misure, becchi diversi, senza vite micrometrica
e nonio 1/20° a richiesta

Andere Groessen, verschiedene Schnaebel, ohne
Feineinstellung und Nonius 1/20 auf Anfrage
Other sizes, different jaws, without fine adjustment
and reading 1/20 on request

001.685*

Calibri officina Midway inox - punte per esterni/interni
nonio 1/50° - monoblocco - astuccio legno - * 8/10 giorni
Werkstattsschiebelehren Midway rostfrei - Aussen/Innen-Spitzen
*Nonius 1/50 - Monoblock - Holzkasten - * 8/10 Tage*
SS Workshop vernier calipers Midway - external/internal upper jaws
*reading 1/50 - monoblock type - wooden box - * 8/10 days*

Codice N° <i>Bestell Nr.</i> <i>Order code</i>	Utile mm <i>Messbereich</i> <i>Capacity</i>	Becchi mm <i>Schnaebel</i> <i>Jaws</i>	Nonio <i>Nonius</i> <i>Reading</i>
Punte esterne - <i>Aussenspitzen</i> - <i>external points</i>			
001.663*	300	90 (5+5)	0,02
001.664*	400	150 (5+5)	0,02
001.665*	500	150 (10+10)	0,02
001.666*	600	150 (10+10)	0,02
001.667*	800	150 (10+10)	0,02
001.668*	1000	150 (10+10)	0,02
Punte interne - <i>Innenspitzen</i> - <i>internal points</i>			
001.683*	300	90 (5+5)	0,02
001.684*	400	150 (5+5)	0,02
001.685*	500	150 (10+10)	0,02
001.686*	600	150 (10+10)	0,02
001.687*	800	150 (10+10)	0,02
001.688*	1000	150 (10+10)	0,02

Calibri digitali officina Midway - da 500mm ABS, preset e min/max - nuovo display numeri grandi - astuccio legno
 Digitale Werkstattschiebelehren Midway - ab 500mm ABS, preset und min/max - neue grosse LCD Anzeige - Holzkasten
 Digital workshop calipers Midway - from 500mm ABS, preset and min/max - new LCD display with big numbers - wooden box

Codice N° Bestell Nr. Order code	Utile mm Messbereich Capacity	Becchi mm Schnaebel Jaws	Nonio Nonius Reading
001.973	300	90 (5+5)	0,01-0.001"
001.972	300	150 (10+10)	0,01-0.001"
001.974	500	100 (10+10)	0,01-0.001"
001.975	500	150 (10+10)	0,01-0.001"
001.976	600	100 (10+10)	0,01-0.001"
001.977	600	150 (10+10)	0,01-0.001"
001.978	800	150 (10+10)	0,01-0.001"
001.980	1000	150 (10+10)	0,01-0.001"
001.981	1500	200 (10+10)	0,01-0.001"
001.982	2000	200 (10+10)	0,01-0.001"
999.996	Pila - Batterie - Battery		

Calibri digitali officina Midway - caratteristiche come serie 228 punte per interni/esterni - astuccio legno - * 8/10 giorni
 Digitale Werkstattschiebelehren Midway - gleiche Ausfuehrung wie Serie 228 - Innen/Aussenspitzen - Holzkasten - * 8/10 Tage
 Digital workshop calipers Midway - characteristics as serie 228 upper jaws for internal/external - wooden box - * 8/10 days

Codice N° Bestell Nr. Order code	Utile mm Messbereich Capacity	Becchi mm Schnaebel Jaws	Nonio Nonius Reading
Modello leggero - leichte Ausf. - light model			
001.904	300	60 (5+5)	0,01-0.001"
999.999	Pila - Batterie - Battery		
Punte esterne - Aussenspitzen - external points			
001.983	300	90 (5+5)	0,01-0.001"
001.985	500	150 (10+10)	0,01-0.001"
001.987*	600	150 (10+10)	0,01-0.001"
001.990*	1000	150 (10+10)	0,01-0.001"
Punte interne - Innenspitzen - internal points			
001.993	300	90 (5+5)	0,01-0.001"
001.995	500	150 (10+10)	0,01-0.001"
001.996*	600	150 (10+10)	0,01-0.001"
001.999*	1000	150 (10+10)	0,01-0.001"
999.996	Pila - Batterie - Battery		

Calibri digitali Vogel - elettronica Sylvac - uscita dati Opto RS232 - astuccio legno - senza vite micrometrica
 Digitale Werkstattschiebelehren Vogel - Sylvac Elektronik mit Opto RS232 Ausgang - Holzkasten - ohne Feinstellung
 Digital workshop calipers Vogel - Sylvac electronic with Opto RS232 socket - wooden box - without fine adjustment screw

Codice N° Bestell Nr. Order code	Utile mm Messbereich Capacity	Becchi mm Schnaebel Jaws	Lettura Abluesung Reading
224.701	300	90 (5+5)	0,01-0.001"
224.702	500	125 (10+10)	0,01-0.001"
224.707	600	125 (10+10)	0,01-0.001"
224.704	1000	150 (10+10)	0,01-0.001"
999.996	Pila - Batterie - Battery		

Calibri digitali Vogel - elettronica Sylvac - uscita dati Opto RS232 - astuccio legno - vite micrometrica - * 3/4 giorni
 Digitale Werkstattschiebelehren Vogel - Sylvac Elektronik mit Opto RS232 Ausgang - Holzkasten - mit Feinstellung - * 3/4Tage
 Digital workshop calipers Vogel - Sylvac electronic with Opto RS232 socket - wooden box - with fine adjustment screw - * 3/4 days

Codice N° Bestell Nr. Order code	Utile mm Messbereich Capacity	Becchi mm Schnaebel Jaws	Lettura Abluesung Reading
Vite microm. - Feinstellung - fine adjustment			
225.701	300	90 (5+5)	0,01-0.001"
225.702*	500	125 (10+10)	0,01-0.001"
225.704*	1000	150 (10+10)	0,01-0.001"
996.701	Cavo - Kabel - Cable		

Calibri digitali officina

Digitale Werkstattschiebelehren
 Digital workshop calipers

Midway
 228



Calibri digitali officina con punte

Digitale Werkstattschiebelehren mit Spitzen
 Digital workshop calipers with upper jaws

Midway
 229

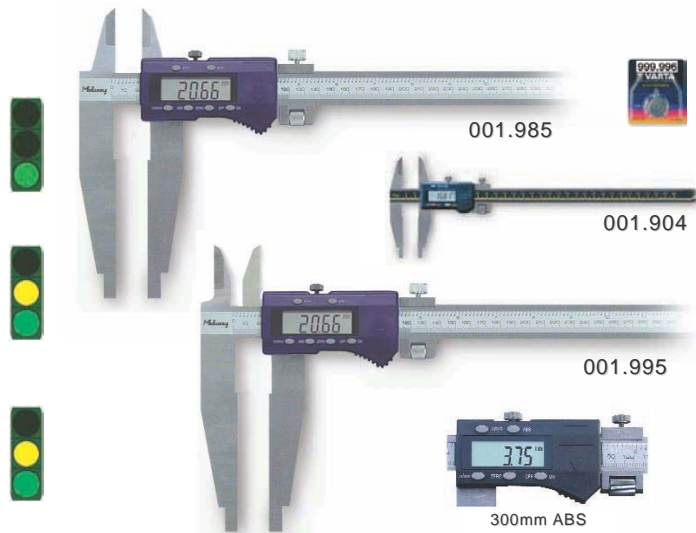

Calibri digitali officina Opto RS232

Digitale Werkstattschiebelehren Opto RS232
 Digital workshop calipers Opto RS232

VOGEL
 224-5

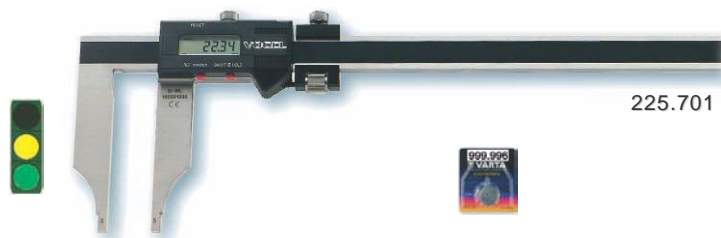

VOGEL

Calibri per gole interne

158

Messschieber fuer Innennuten
Vernier calipers for internal grooves

Misure becchi/contatti a confermare
Masse Schnaebel/Kontakte zu bestaetigen
Sizes jaws/contacts to be confirmed

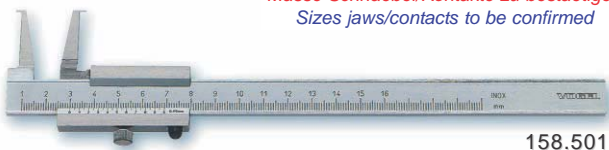

158.501

Calibri rovesci per gole interne - puntalini fissi vedi tabella nonio 1/20 - bloccaggio vite - astuccio legno
Messschieber fuer Innennuten - feste Messkontakte siehe Tabelle
Feststellschraube - Nonius 1/20 - Holzetui
Calipers for internal grooves - fix measuring contacts see list below screw lock - reading 1/20 - wooden box

Codice N°	Utile mm	Becchi mm	Piedini
<i>Bestell Nr.</i>	<i>Messbereich</i>	<i>Schnaebel</i>	<i>Kontakte</i>
<i>Order code</i>	<i>Capacity</i>	<i>Jaws</i>	<i>Contacts</i>
158.501	10:160	25	1,1 L 3,0
158.502	20:160	40	2,0 L 5,0
158.503	26:200	60	3,0 L 7,0
158.504	30:250	80	4,0 L 8,5
158.505	35:300	100	5,0 L 10

Midway

Calibri digitali per gole interne

257

Digitale Messschieber fuer Innennuten
Digital calipers for internal grooves

Misure becchi/contatti a confermare
Masse Schnaebel/Kontakte zu bestaetigen
Sizes jaws/contacts to be confirmed

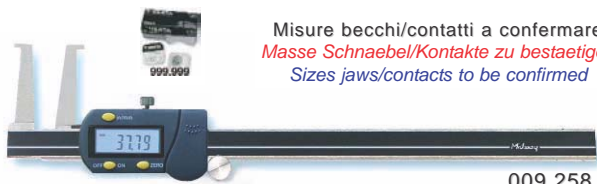

009.258

Lettura diretta - *Direktablesung* - direct reading

Calibri per gole interne - puntalini fissi vedi tabella - elettronica "preset" - lettura 0,01mm - astuccio legno - anello di riscontro
Messschieber fuer Innennuten - feste Messkontakte siehe Tabelle
"Preset" Elektronik - Ablesung 0,01mm - Holzetui - Einstellring
Calipers for internal grooves - fix measuring contacts see list below "preset" electronic - reading 0,01mm - wooden box - setting ring

Codice N°	Utile mm	Becchi mm	Piedini
<i>Bestell Nr.</i>	<i>Messbereich</i>	<i>Schnaebel</i>	<i>Kontakte</i>
<i>Order code</i>	<i>Capacity</i>	<i>Jaws</i>	<i>Contacts</i>
009.257	10:160	26	1,2 L 2,8
009.258	10:210	28	1,2 L 3,2
009.259	10:310	35	1,2 L 4,5
999.999			Pila - Batterie - Battery

Midway

Calibri digitali per gole interne/esterne

130

Digitale Messschieber Innen- und Aussennuten
Digital calipers for internal/external grooves



009.729

009.709

001.955

Calibri digitali per gole interne ed esterne - elettronica "preset" - lettura 0,01mm - becchi con foro passante filettato M 2,5 per puntalini comparatori - astuccio legno
Digitale Messschieber fuer Innen- und Aussennuten - "Preset" Elektronik - Ablesung 0,01mm - Schnaebel mit durchgehender Bohrung Gewinde M 2,5 fuer Messeinsaetze Messhuen - Holzetui
Digital calipers for internal and external grooves - "preset" electronic reading 0,01mm - jaws with throughpassing hole threaded M 2,5 for measuring contacts of dial gauges - wooden box

Codice N°	Utile mm	Becchi - L - Larghezza
<i>Bestell Nr.</i>	<i>Messbereich</i>	<i>Schnaebel - L - Breite</i>
<i>Order code</i>	<i>Capacity</i>	<i>Jaws - length - width</i>
009.709	150	50 5 + 5
009.729	200	83 7 + 7
999.999		Pila - Batterie - Battery
001.953	300	90 12 + 12
001.955	500	150 16 + 16
999.996		Pila - Batterie - Battery

Ø intero minimo = 2 x larghezza becchi (10 o 14mm)
+ 2 x lunghezza dei puntalini scelti (710.197 = 6+6 - Ø4,5mm)
Ø interno massimo = come sopra + utile nominale calibro
Innen Ø Minimum = 2 x Breite der Schnaebel (10 oder 14mm)
+ 2 x Laenge der ausgesuchten Messeinsaetze (710.197 = 6+6 - Ø4,5mm)
Innen Ø Maximum = wie oben + nominaler Messbereich Schiebelehre
Inside Ø minimum = 2 x width of jaws (10 or 14mm)
+ 2 x length of the chosen measuring contacts (710.197 = 6+6 - Ø4,5mm)
Inside Ø maximum = as above + nominal capacity of caliper

VOGEL

Calibri digitali per gole interne/esterne

226-30

Digitale Messschieber Innen- und Aussennuten
Digital calipers for internal/external grooves



226.738

230.729

230.709

Calibri come serie 130 sopra con elettronica Sylvac preset uscita dati Opto RS232
Messschieber wie Serie 130 oben mit Elektronik Sylvac Preset und Datenausgang Opto RS232
Calipers as series 130 above with Sylvac preset electronics and data socket Opto RS232

Codice N°	Utile mm	Becchi - L - Larghezza
<i>Bestell Nr.</i>	<i>Messbereich</i>	<i>Schnaebel - L - Breite</i>
<i>Order code</i>	<i>Capacity</i>	<i>Jaws - length - width</i>
230.709	150	50 5 + 5
230.729	200	83 7 + 7

Codice N°	Utile mm	Becchi - L - Larghezza
<i>Bestell Nr.</i>	<i>Messbereich</i>	<i>Schnaebel - L - Breite</i>
<i>Order code</i>	<i>Capacity</i>	<i>Jaws - length - width</i>
226.738	300	90 12 + 12
226.758	500	100 16 + 16
999.996		Pila - Batterie - Battery

2 puntalini in dotazione 710.197 - altri puntalini vedi 4/14-15
Lieferung mit 2 Messeinsaetzen 710.197 - andere Einsaetze 4/14-15
Delivery with 2 contacts 710.197 - other contacts see 4/14-15

Ponti di profondità per quasi tutti i calibri tascabili 150, 200 o 300mm - forma variabile - sacchetto plastica
Tiefenmessbruecke fuer fast alle Taschenschiebelehren 150, 200 oder 300mm - unterschiedliche Form - Plastikbeutel
 Depth bridge for most types of pocket vernier calipers 150, 200 or 300mm - different shapes - plastic bag

Codice N°	Calibro	Base	Sezione
<i>Bestell Nr.</i>	<i>Schiebelehre</i>	<i>Base</i>	<i>Querschnitt</i>
<i>Order code</i>	<i>Caliper</i>	<i>Base</i>	<i>Section</i>
001.510	150-200	75x6,5x30	16,1x4
001.511	300	80x6,5x30	20,0x4



Ponti di profondità per calibri tascabili **Midway**
Tiefenmessbruecken fuer Schiebelehren **271**
 Depth bridges for vernier calipers



Calibri di profondità Vtec - monoblocco o con nonio avvitato nonio 1/20 o 1/50 - astuccio legno o plastica - * 8/10 giorni
*Tiefenmessschieber Vtec - Monoblock oder mit Schraubnonius Nonius 1/20 oder 1/50 - Holzkasten oder Plastiketui - * 8/10 Tage*
 Depth vernier calipers Vtec - monoblock or with screwed vernier reading 1/20 or 1/50 - wooden or plastic box - * 8/10 days

Codice N°	Utile mm	Base mm	Lettura
<i>Bestell Nr.</i>	<i>Messbereich</i>	<i>Bruecke</i>	<i>Ablesung</i>
<i>Order code</i>	<i>Capacity</i>	<i>Bridge</i>	<i>Reading</i>
<i>Standard - Standard - Standard</i>			
001.502	200	100	0,02
001.503	300	100	0,02
001.505	500	150	0,02
<i>Gancio - Haken - Hook</i>			
001.512	200	100	0,02
001.513	300	100	0,02
001.515*	500	120	0,02
<i>2 ganci - 2 Winkel - 2 Hooks</i>			
001.592	200	100	0,02
001.593	300	100	0,02



Calibri di profondità semplici **Vtec**
Einfache Tiefenmessschieber **266**
 Simple depth calipers

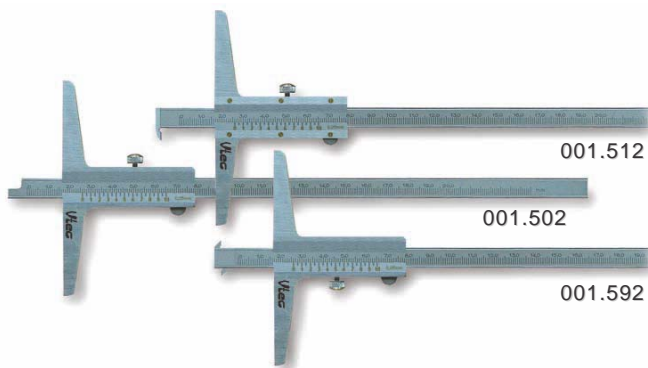

Calibri di profondità Vogel - contatto standard - nonio 0,02 a richiesta nonio 0,05mm - astuccio legno fornibili fino a 2000mm
Tiefenmasse Vogel - Standardkontakt - Nonius 0,02 auf Anfrage Nonius 0,05mm - Holzkasten lieferbar bis 2000mm
 Depth calipers Vogel - standard contact - reading 0,02 on request reading 0,05mm - wooden box available up to 2000mm

Codice N°	Utile mm	Base mm	Nonio
<i>Bestell Nr.</i>	<i>Messbereich</i>	<i>Bruecke</i>	<i>Nonius</i>
<i>Order code</i>	<i>Capacity</i>	<i>Bridge</i>	<i>Reading</i>
282.521	150	100	0,02
282.522	200	100	0,02
282.523	300	100	0,02
282.524	250	130	0,02
282.525	300	150	0,02
282.527	500	150	0,02
282.528	500	250	0,02



Calibri di profondità standard **VOGEL**
Tiefenmessschieber Standard **282**
 Depth calipers standard



Calibri di profondità Vogel - punta intercambiabile - nonio 0,02 a richiesta nonio 0,05mm - astuccio legno - asta invertibile con doppia graduazione (lato B come modello 282)
Tiefenmasse Vogel - auswechselbarer Messstift - Nonius 0,02 auf Anfrage Nonius 0,05mm - Holzkasten - umsteckbare Messstange mit beidseitiger Skalierung (Seite B wie Modell 282)
 Depth calipers Vogel - interchangeable measuring pin - reading 0,02 on request reading 0,05mm - wooden box - invertible measuring rod with double graduation (side B as model 282)

Codice N°	Utile mm	Base mm	Punta
<i>Bestell Nr.</i>	<i>Messbereich</i>	<i>Bruecke</i>	<i>Spitze</i>
<i>Order code</i>	<i>Capacity</i>	<i>Bridge</i>	<i>Point</i>
281.521	150	100	Ø 1,5
281.522	200	100	Ø 1,5
281.524	250	130	Ø 2,0
281.525	300	150	Ø 2,0



Calibri di profondità con punta **VOGEL**
Tiefenmessschieber mit Spitze **281**
 Depth calipers with needle

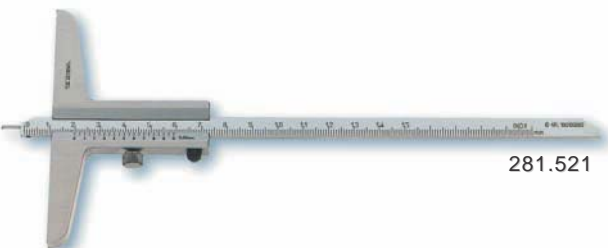

999.015*	Punta - Spitze - needle - Ø 1,5mm (521-522)
999.016*	Punta - Spitze - needle - Ø 2,0mm (524-525)

VOGEL

Calibri di profondità con gancio

286

Tiefenmessschieber mit Haken
Depth calipers with hook

Fino a 2000mm a richiesta
bis 2000mm auf Anfrage
Up to 2000mm on request



286.521

Calibri di profondità Vogel - contatto con gancio - nonio 0,02 a richiesta nonio 0,05mm - astuccio legno - asta invertibile con doppia graduazione (lato B come modello 282)

Tiefenmasse Vogel - Messkontakt mit Haken - Nonius 0,02 auf Anfrage Nonius 0,05mm - Holzkasten - umsteckbare Messstange mit beidseitiger Skalierung (Seite B wie Modell 282)

Depth calipers Vogel - measuring contact with hook - reading 0,02 on request reading 0,05mm - wooden box - invertible measuring rod with double graduation (side B as model 282)



Codice N° <i>Bestell Nr.</i>	Utile mm <i>Messbereich</i>	Base mm <i>Bruecke</i>	Nonio <i>Nonius</i>
Order code	Capacity	Bridge	Reading
286.521	150	100	0,02
286.522	200	100	0,02
286.523	300	100	0,02
286.524	250	130	0,02
286.525	300	150	0,02
286.527	500	150	0,02

VOGEL

Calibri di profondità doppio gancio

292

Tiefenmessschieber mit doppeltem Haken
Depth calipers with double hook

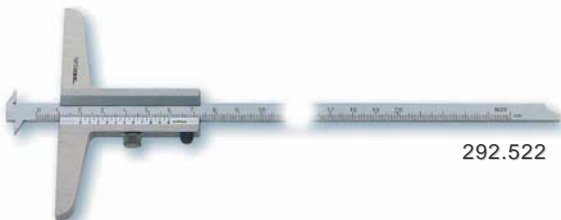

292.522

Calibri di profondità Vogel - contatto con doppio gancio nonio 0,02 a richiesta nonio 0,05mm - astuccio legno - asta invertibile con doppia graduazione (lato B come modello 282)

Tiefenmasse Vogel - Messkontakt mit Doppelhaken - Nonius 0,02 auf Anfrage Nonius 0,05mm - Holzkasten - umsteckbare Messstange mit beidseitiger Skalierung (Seite B wie Modell 282)

Depth calipers Vogel - measuring contact with double hook - reading 0,02 on request reading 0,05mm - wooden box - invertible measuring rod with double graduation (side B as model 282)



Codice N° <i>Bestell Nr.</i>	Utile mm <i>Messbereich</i>	Base mm <i>Bruecke</i>	Nonio <i>Nonius</i>
Order code	Capacity	Bridge	Reading
292.522	200	100	0,02
292.523	300	100	0,02

Vtec

Calibri di profondità digitali

270

Digital-Tiefenmessschieber
Digital depth calipers

Tutti modelli 001.9... tranne 009.3...
Alle Modelle 001.9... ausser 009.3...
Il models 001.9... except 009.3...



001.916

Calibri di profondità digitali Vtec - lettura 0,01mm astuccio legno - * 8/10 giorni

*Digitale Tiefenmessschieber Vtec - Ablesung 0,01mm Holzkasten - * 8/10 Tage*

Digital depth vernier calipers Vtec - reading 0,01mm wooden box - * 8/10 days



Codice N° <i>Bestell Nr.</i>	Utile mm <i>Messbereich</i>	Base mm <i>Bruecke</i>	Letture <i>Ablesung</i>
Order code	Capacity	Bridge	Reading
Standard - <i>Standard</i> - <i>Standard</i>			
001.914	200	100	0,01
001.917*	200	150	0,01
001.913*	300	100	0,01
001.916	300	150	0,01
001.915*	500	150	0,01
001.918*	1000	250	0,01



001.934*



Punta - <i>Spitze</i> - <i>Punta</i>			
001.934*	200	100	0,01
001.937*	200	150	0,01
001.933*	300	100	0,01
001.936*	300	150	0,01



001.924*



Gancio - <i>Haken</i> - <i>Hook</i>			
001.924*	200	100	0,01
001.923*	300	100	0,01
001.925*	500	120	0,01



001.931*



2 ganci - <i>2 Haken</i> - <i>2 hooks</i>			
001.931*	200	100	0,01
999.999	Pila - <i>Batterie</i> - <i>Battery</i>		

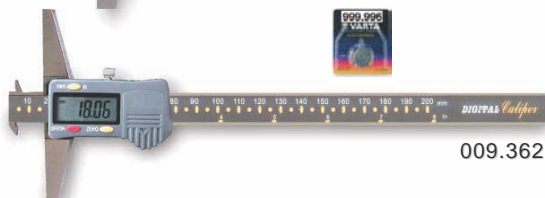

009.362



Doppio gancio - <i>Doppelhaken</i> - <i>Double angle</i>			
009.362	200	100	0,01
009.373	300	150	0,01
009.375	500	150	0,01
999.996	Pila - <i>Batterie</i> - <i>Battery</i>		

Calibri digitali di profondità Midway - contatti di misurazione vedi tabella - lettura 0,01mm - asta stretta - astuccio legno
 Digital-Tiefenmessschieber Midway - Messkontakte siehe Tabelle
 Ablesung 0,01mm - schmaler Messstab - Holzkasten
 Digital depth calipers Midway - measuring contacts see list reading 0,01mm - narrow scale - wooden box

Codice N° Bestell Nr. Order code	Utile mm Messbereich Capacity	Base mm Bruecke Bridge	Lettura Ablesung Reading
Standard - Standard - Standard			
009.302	200	100	0,01
009.303	300	100	0,01
009.312	200	150	0,01
009.313	300	150	0,01
009.315	500	150	0,01
Punta fissa - feste Spitze - fix needle			
009.322	200	100	0,01
009.333	300	150	0,01
Gancio - Haken - Angle			
009.342	200	100	0,01
009.353	300	150	0,01
009.355	500	150	0,01
999.999 Pila - Batterie - Battery			



Calibri di profondità digitali Midway

Digital-Tiefenmessschieber 269
 Digital depth calipers

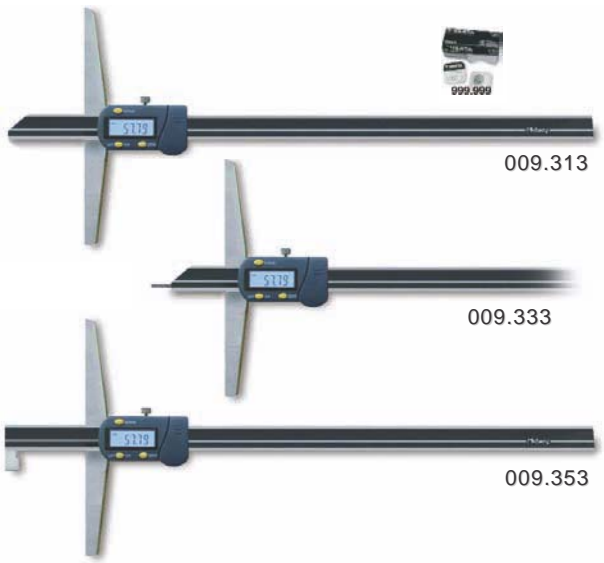

Calibri digitali di profondità con base supplementare - contatto multiuso avvitato - astuccio legno - * a richiesta
 Digitale Tiefenmasse mit Zusatzbruecke - angeschraubter Universalkontakt - Holzkasten - * auf Anfrage
 Digital depth calipers with mobile extension base - screwed multipurpose contact - wooden box - * on request

Codice N° Bestell Nr. Order code	Utile mm Messbereich Capacity	Base mm Bruecke Bridge	Lettura Ablesung Reading
001.919*	300	160/300	0,01-0.001"
001.920*	500	160/500	0,01-0.001"
999.999 Pila - Batterie - Battery			

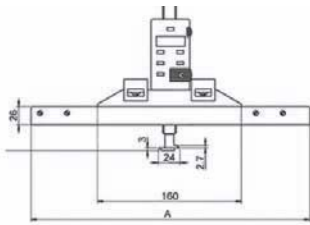

Calibri di profondità con ponte mobile Midway

Tiefenmessschieber mit beweglicher Bruecke 272
 Depth calipers with mobile extension base



Calibri digitali di profondità Vogel - elettronica Sylvac Opto RS232 - lettura 0,01mm - astuccio legno - * 4/5 giorni
 Digitale Tiefenmasse Vogel - Sylvac Elektronik Opto RS232
 Ablesung 0,01mm - Holzkasten - * 4/5 Tage
 Digital depth calipers Vogel - Sylvac electronic Opto RS232 reading 0,01mm - wooden box - * 4/5 days

Codice N° Bestell Nr. Order code	Utile mm Messbereich Capacity	Base mm Bruecke Bridge	Lettura Ablesung Reading
Standard - Standard - Standard			
274.700	200	100	0,01-0.001"
274.701	300	150	0,01-0.001"
274.702*	500	150	0,01-0.001"

Codice N° Bestell Nr. Order code	Utile mm Messbereich Capacity	Base mm Bruecke Bridge	Lettura Ablesung Reading
Gancio - Haken - Hook			
275.701*	300	150	0,01-0.001"
275.702*	500	150	0,01-0.001"

Codice N° Bestell Nr. Order code	Utile mm Messbereich Capacity	Base mm Bruecke Bridge	Lettura Ablesung Reading
Doppio gancio - Doppelhaken - Double angle			
278.700	200	100	0,01-0.001"
278.701	300	150	0,01-0.001"

999.996 Pila - Batterie - Battery



Calibri digitali di profondità VOGEL

Digitale Tiefenmessschieber 274-5-8
 Digital depth calipers



Altre misure fino a 2000 a richiesta
 andere Groessen bis 2000 auf Anfrage
 other sizes up to 2000 on request

Vtec
261

Calibri per profondità chiavette

Messschieber fuer Keilnutentiefen
Vernier calipers for groove depths



Calibri per chiavette - 1° corsoio per l'azzeramento sull'albero
2° per la profondità della cava - avvolti in carta
Schiebelehren fuer Keilnuten - 1. Schieber zum Nullen auf der Welle
2. *Schieber fuer Nutentiefe - in Papier gewickelt*
Calipers for groove depths - 1st vernier for zero setting on round shaft - 2nd vernier for groove depth - paper wrapped

Codice N°	Min Ø	Max Ø	Nonio
Bestell Nr.	Min Ø	Max Ø	Nonius
Order code	Min Ø	Max Ø	Reading
001.261	5	80	0,05
001.262	6	120	0,05

Midway
263

Calibri utensili a 3 o 5 taglienti

Messschieber fuer 3/5 schneidige Werkzeuge
Vernier calipers for 3/5 point cutting tools

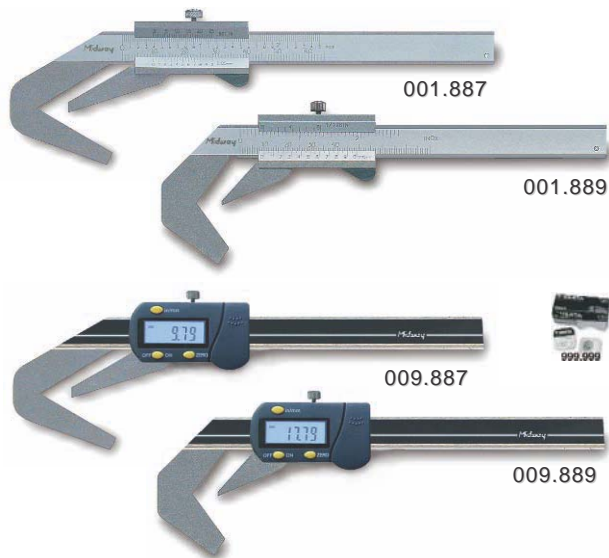

Calibri Midway per utensili a 3(9) o 5 taglienti - nonio 1/20
oppure digitale - becchi angolati - scatola cartone
Schiebelehren Midway fuer 3(9) oder 5 scheidige Werkzeuge
Nonius 1/20 oder digital - winklige Schnaebel - Kartonschachtel
Vernier calipers Midway for 3(9) or 5 pointed cutting tools
reading 1/20 or digital - angle jaws - carton box

Codice N°	Utile min - max mm	Nonio
Bestell Nr.	Messbereich min - max	Nonius
Order code	Capacity min - max	Reading
3 taglienti - 3 schneidig - 3 point cut		
001.887	4 - 40	0,05
001.888	20 - 75	0,05
5 taglienti - 5 schneidig - 5 point cut		
001.889	1 - 40	0,05

Codice N°	Utile min - max mm	Letture
Bestell Nr.	Messbereich min - max	Ablesung
Order code	Capacity min - max	Reading
3 taglienti - 3 schneidig - 3 point cut		
009.887	4 - 40	0,01
5 taglienti - 5 schneidig - 5 point cut		
009.889	1 - 40	0,01
999.999	Pila - Batterie - Battery	

Midway
262

Calibri digitali per gole esterne

Digitalschiebelehren fuer Aussennuten
Digital calipers for external grooves

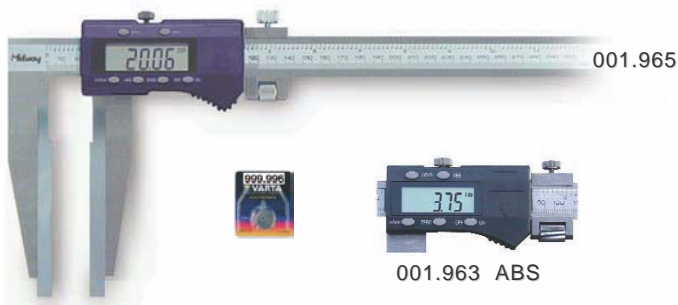

Calibri digitali Midway per gole esterne - da 500mm ABS
preset e min/max - display numeri grandi - astuccio legno
Digitale Aussennutenschiebelehren Midway - ab 500mm ABS
preset und min/max - grosse LCD Anzeige - Holzkasten
Digital calipers Midway for outside grooves - from 500mm ABS
preset and min/max - LCD display with big numbers - wooden box



Superfici di misura ribassati 1,5x8mm
Abgeflachte Messflaechen 1,5x8mm
Lowered measuring surfaces 1,5x8mm

Codice N°	Utile mm	Becchi mm	Nonio
Bestell Nr.	Messbereich	Schnaebel	Nonius
Order code	Capacity	Jaws	Reading
001.963	300	90 (5+5)	0,01/0.001"
001.965	500	150 (10+10)	0,01/0.001"
999.996	Pila - Batterie - Battery		

Midway
268

Calibri digitali per ingranaggi

Digitalschiebelehren fuer Zahnraeder
Digital gear tooth calipers



Calibri digitali Midway per ingranaggi - doppio corsoio
lettura 0,01mm/0.001" - astuccio legno - * 30/60 giorni
Digitalschiebelehren fuer Zahnraeder - doppelter Schieber
*Ablesung 0,01mm/0.001" - Holzkasten - * 30/60 Tage*
Digital gear tooth calipers - double slider - reading 0,01mm
or 0.001" - wooden box - * 30/60 days

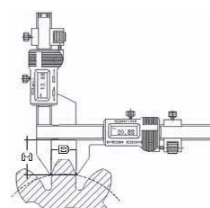

Codice N°	Modulo	A x B	Nonio
Bestell Nr.	Modul	A x B	Nonius
Order code	Modul	A x B	Reading
001.268	1 - 25	30,5x21	0,01/0.001"
001.269*	5 - 50	50,5x50	0,01/0.001"
999.999	Pila - Batterie - Battery		

Righe digitali orizzontali Midway - uscita dati - lettura 0,01mm da 500 con preset - attacchi montaggio - scatola cartone
 Digitale Einbaumessschieber waagrecht Midway - ab 500 mit Preset
 Datenausgang - Ablesung 0,01mm - Montageelemente - Karton
 Digital built-in calipers Midway horizontal type - from 500 with preset data socket - reading 0,01mm - fixing clamps - carton box

Codice N°	Utile mm	Lettura	
<i>Bestell Nr.</i>	<i>Messbereich</i>	<i>Ablesung</i>	<i>Ablesung</i>
<i>Order code</i>	<i>Capacity</i>	<i>Reading</i>	<i>Reading</i>
009.700	100	0,01	0.001"
009.701	150	0,01	0.001"
009.702	200	0,01	0.001"
009.703	300	0,01	0.001"
con Preset - mit Preset - with Preset			
009.705	500	0,01	0.001"
009.710	1000	0,01	0.001"
999.999	Pila - Batterie - Battery		

Righe digitali orizzontali Midway - uscita dati - lettura 0,01mm funzione preset - attacchi montaggio - scatola cartone
 Digitale Einbaumessschieber waagrecht Midway - Presetfunktion
 Datenausgang - Ablesung 0,01mm - Montageelemente - Karton
 Digital built-in calipers Midway horizontal type - preset function data socket - reading 0,01mm - fixing clamps - carton box

Codice N°	Utile mm	Lettura	
<i>Bestell Nr.</i>	<i>Messbereich</i>	<i>Ablesung</i>	<i>Ablesung</i>
<i>Order code</i>	<i>Capacity</i>	<i>Reading</i>	<i>Reading</i>
con Preset - mit Preset - with Preset			
009.751	150	0,01	0.001"
009.752	200	0,01	0.001"
009.753	300	0,01	0.001"
009.755	500	0,01	0.001"
009.760	1000	0,01	0.001"
999.999	Pila - Batterie - Battery		

Visualizzatori LCD ad 1 asse incl. 1 cavo - on/off - in/mm 0 zero - dorso magnetico - alimentazione pila 3V
 Anzeigegeraete LCD 1 Achse mit 1 Kabel - on/off - in/mm - 0 null
 Stromversorgung Batterie 3V - Rueckwand magnetisch
 Displays LCD 1 axis with 1 cable - on/off - in/mm - 0 zero electric power 1 battery 3V - magnetic back

1 asse - 1 Achse - 1 axis		
009.901	X - 2x1,5V pila	Batterie - battery
999.993	(2x)	Pila - Batterie - Battery

Visualizzatori LCD a 2 o 3 assi incl. 2/3 cavi - trasformatore 220/5V compreso - on/off - in/mm - 0 zero - 1/2 (asse X)
 Anzeigegeraete LCD fuer 2 oder 3 Achsen mit 2/3 Kabeln - Trafo 220/5V inklusiv - on/off - in/mm - 0 null - 1/2 (X-Achse)
 Displays LCD for 2 or 3 axis with 2/3 connection cables - transformer 220/5V included - on/off - in/mm - 0 zero - 1/2 (X axis)

2/3 assi - 2/3 Achsen - 2/3 axis		
009.902	X - Y - 220 / 5 V	1500mA
009.903	X-Y-Z - 220 / 5 V	1500mA

Stampanti per strumenti digitali - incl. trasformatore 220V pedale con cavo e cavo collegamento strumento
 Drucker fuer Digitalinstrumente - inbegriffen Transformator 220V
 Pedal mit Kabel und Verbindungskabel Messmittel
 Printers for digital instruments - inclusive transformer 220V pedal with cable and connecting cable for the instrument

009.930	stampante	Drucker	printer
---------	-----------	---------	---------

Funzioni stampante: limite superiore, limite inferiore, tolleranza, numero misure, valore medio, valore massimo, valore minimo differenza min/max, differenza standard, numero e percentuale valori fuori limiti min e max, istogramma
 Druckerfunktionen: oberes Limit, unteres Limit, Tolleranz, Anzahl Messwerte, Mittelwert, Maximalwert, Minimalwert, Differenz zwischen min/max, Standard-differenz, Anzahl und Prozentsatz der Messungen ausserhalb des min/max Limits - Histogramm
 Printer functions: upper limit, lower limit, tolerance, quantity of data collected, average value, maximum value, minimum value, difference min/max, standard difference, number and percentage of values out of upper and lower limits - histogram

Righe digitali orizzontali/verticali

Midway
253

Digitale Anbaumessschieber waager./senkr.
 Digital built-in calipers horizontal/vertical

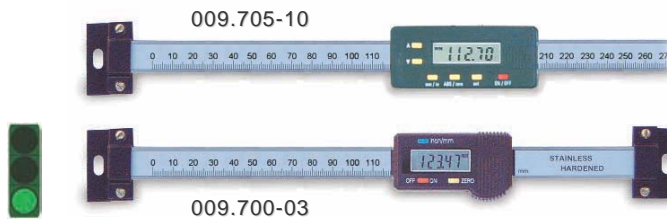

A richiesta serie 272-273 con elettronica Sylvac uscita dati Opto Rs232
 Auf Anfrage Serie 272-273 mit Sylvac Elektronik und Datenausgang Opto RS232
 On request series 272-273 with Sylvac electronics and data socket Opto RS232



Visualizzatori e stampanti

Midway
255

Anzeigegeraete und Drucker
 External display and printers



VOGEL

Calibri orologio

218

Uhrenschiebelehren
Dial calipers



Pagina **1/03** 218.501
Seite
Page



Codice N°	Utile mm	Becchi mm	Letture
<i>Bestell Nr.</i>	<i>Messbereich</i>	<i>Schnaebel</i>	<i>Ablesung</i>
<i>Order code</i>	<i>Capacity</i>	<i>Jaws</i>	<i>Reading</i>
Nuova misura - <i>neue Laenge</i> - <i>new length</i>			
218.503	300	60	0,01

Calibri ad orologio Vogel qualità extra lettura 0,02 o 0,01mm - astuccio plastica
Uhrenschiebelehren Vogel von hoher Qualitaet
Ablesung 0,02 oder 0,01mm - Plastiketui
Dial calipers Vogel of extra quality reading 0,02 or 0,01mm - plastic box

VOGEL

Calibri digitali - cassa metallica

205

Digitalschiebelehren mit Metallgehause
Digital calipers with metal case



Pagina **1/05** 205.150
Seite
Page



Codice N°	Utile mm	Becchi mm	Letture
<i>Bestell Nr.</i>	<i>Messbereich</i>	<i>Schnaebel</i>	<i>Ablesung</i>
<i>Order code</i>	<i>Capacity</i>	<i>Jaws</i>	<i>Reading</i>
Nuova misura - <i>neue Laenge</i> - <i>new length</i>			
205.100	100	30	0,01-0.001"
999.999	Pila - <i>Batterie</i>		<i>Battery</i>

Calibri digitali Vogel - lettura 0,01mm/0.001" - cassa metallica argento - display grande - scatola plastica
Digitalschiebelehren Vogel - Ablesung 0,01mm/0.001" - silbernes Metallgehause - grosses Display - Plastiketui
Digital calipers Vogel - reading 0,01mm/0.001" - silver metal case display LCD with big numbers - plastic box

Midway

Cinquantesimali - monoblocco

232

Werkstattschiebelehren Monoblock
Workshop calipers monoblock

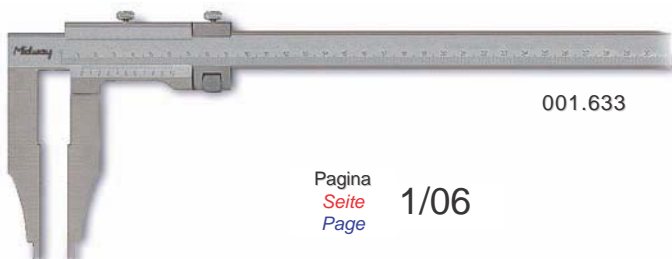

Pagina **1/06** 001.633
Seite
Page



Codice N°	Utile mm	Becchi mm	Nonio
<i>Bestell Nr.</i>	<i>Messbereich</i>	<i>Schnaebel</i>	<i>Nonius</i>
<i>Order code</i>	<i>Capacity</i>	<i>Jaws</i>	<i>Reading</i>
Nuove misure - <i>neue Laengen</i> - <i>new lengths</i>			
001.775	1000	300 (10+10)	0,02
001.641	1500	300 (10+10)	0,02

Calibri officina Midway inox - nonio 1/50° - monoblocco a richiesta anche 1/20°/0,05 - astuccio legno
Werkstattschiebelehren Midway rostfrei - Nonius 1/50 - Monoblock auf Anfrage 1/20°/0,05 - Holzkasten
SS Workshop vernier calipers Midway - vernier 1/50 on request 1/20°/0,05 - wooden box

Midway

Calibri digitali officina con punte

229

Digitale Werkstattschiebelehren mit Spitzen
Digital workshop calipers with upper jaws



Pagina **1/07** 001.995
Seite
Page



Codice N°	Utile mm	Becchi mm	Nonio
<i>Bestell Nr.</i>	<i>Messbereich</i>	<i>Schnaebel</i>	<i>Nonius</i>
<i>Order code</i>	<i>Capacity</i>	<i>Jaws</i>	<i>Reading</i>
Punte interne - <i>Innenspitzen</i> - <i>internal points</i>			
001.996*	600	150 (10+10)	0,01-0.001"
001.999*	1000	150 (10+10)	0,01-0.001"
999.996	Pila - <i>Batterie</i>		<i>Battery</i>

Calibri digitali officina Midway - caratteristiche come serie 228 punte per interni/esterni - astuccio legno - * 8/10 giorni
*Digitale Werkstattschiebelehren Midway - gleiche Ausfuehrung wie Serie 228 - Innen/Aussenspitzen - Holzkasten - * 8/10 Tage*
Digital workshop calipers Midway - characteristics as serie 228 upper jaws for internal/external - wooden box - * 8/10 days

Spazio per le Vs. annotazioni

Bereich fuer Ihre Notizen
Space for Your notes

1

CALIBRI - SCHIEBELEHREN - CALIPERS